

EKWT-ESRT-A4.400-DC2K-x

Actuator and Sensor Cordset – Extension Cable

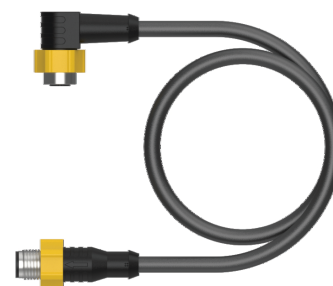
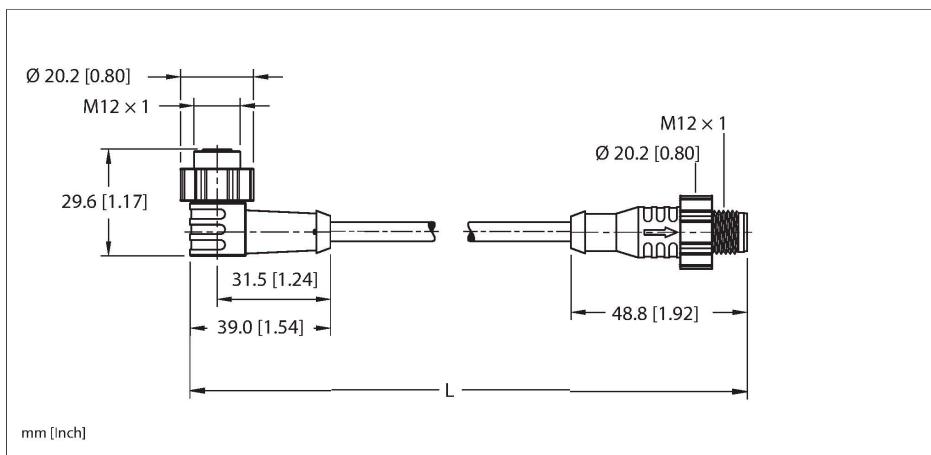

Technical data

Type	EKWT-ESRT-A4.400-DC2K-x
ID	777046443
Replaces	WK 4.4T-x-RS 4.4T/S618
Connector A	Female, M12 × 1, Right angle, A-code
Design specification	Acc. to IEC 61076-2-101
Number of contacts	4
Contacts	Bronze, CuSn, Gold-plated
Contact carriers	Plastic, Nylon or TPU, Black
Connector body	Plastic, TPU, Black
Coupling nut	Brass, CuZn, Nickel-plated
Connector seal	O-ring, Plastic, FKM/FPM
Torque sleeve	Plastic, PA, Yellow
Tightening torque (range)	0.4 ... 1.8 Nm (note max. torque of mating connector!)
Mechanical life	> 100 Mating cycles
Pollution degree	3
Protection class (When coupled)	IP67, IP68, IP69, IP69K NEMA: 1, 3, 4, 6P, 12
Connector B	Male, M12 × 1, Straight, A-code
Design specification	Acc. to IEC 61076-2-101
Number of contacts	4
Contacts	Bronze, CuSn, Gold-plated
Contact carriers	Plastic, Nylon or TPU, Black
Connector body	Plastic, TPU, Black
Coupling nut	Brass, CuZn, Nickel-plated

Features

-
- M12, Female, Right angle, 4-pin, Torque sleeve
- M12, Male, Straight, 4-pin, Torque sleeve
- Instrumentation Tray Cable
- Black PVC jacket, shielded, 4X22 AWG
- Sunlight Resistant
- -40 Cold Bend Rating
- Oil Resistant
- Flame Ratings: UL 1685 FT4, UL1061, CSA FT4

Cable cross section

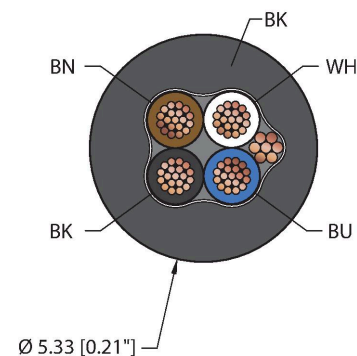

Contact assignment

Technical data

Torque sleeve	Plastic, PA, Yellow
Tightening torque	0.4 ... 1.8 Nm (note max. torque of mating connector!)
Mechanical life	> 100 Mating cycles
Pollution degree	3
Protection class (When coupled)	IP67, IP68, IP69, IP69K
	NEMA: 1, 3, 4, 6P, 12

Cable data	
Cable ID	RF50805
Total number of conductors	4
Cable diameter	Ø 5.33 mm
Cable jacket	PVC, Black
Shield	Aluminum/polyester (IN)
Cable drain	24 AWG, TC (Tinned Copper)
Conductor diameter	0.054 "
Conductor material	TC (tinned copper)
Conductor insulation material	PVC
Conductor size	4 x 22 AWG [Similar to 0.34 mm ²]
Number of strands x O.D.	19 x 0.0058 "
Conductor colors	BN, WH, BU, BK

Electrical properties at +20 °C	
Rated voltage	250 V _{AC} /300 V _{DC}
Current	4 A

Mechanical and chemical properties	
Bending radius (static)	≥ 5 x Ø
Bending radius (dynamic)	≥ 15 x Ø
UL cold bend rating	-40 °C
Ambient temperature range (static)	-40 °C...+105 °C
Ambient temperature range (dynamic)	5 °C...+105 °C
Temperature range (installation)	-10 °C...+105 °C

Approval	
Approvals	UL 2238 CSA C22.2 No. 182.3 CE UKCA RoHS

Note	
	- Flex ratings may be reduced if used in extreme temperatures, exposure to certain chemicals, operating above the

Connector A

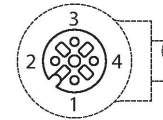

Connector B

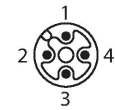

Circuit Diagram

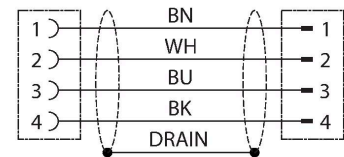

Technical data

rated cycle speed, or operating below the rated cable bend radius.

- The torque sleeve can be removed, before or after installation by inserting a small flat screwdriver near the relief by the arrow and prying.

- We reserve the right to make technical alterations without prior notice.

Accessories

M12-TORQUE-SLEEVE,YELLOW(10PACK)

A900167



10 Pack of Yellow Torque Sleeves for the new M12 cordsets. Compatible with male, female, straight and right-angled, stainless steel and nickel-plated brass coupling nuts.

TORQUE-WRENCH-SET-M12/SW13

A900152

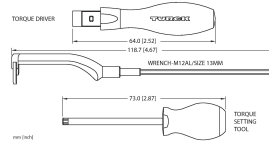

Adjustable torque driver to connect to the 13mm hex. Compatible with redesigned M12 cordsets, M12 Power, and M12 X-code. NOT Compatible with legacy M12 cordsets. Includes (1) adjustable torque driver, (1) adjustment tool, and (1) 13mm forked bit.

Accessories

M12-CORDSETS-MOUNTING-CLIP-(10/BAG)

100016882

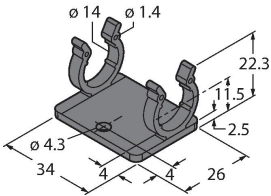

10 Pack of black mounting clips and M4x8mm mounting screws, used to secure cable to cable connection points.